

EX-G013A v1.3 / EX-G013B v1.3
EX-G015 / EX-G016
EX-G083 / EX-G076B

HDMI 1.3 over Single CAT5 Distribution Series

User Manual

EX-G013A v1.3



EX-G013B v1.3



EX-G015



EX-G016



EX-G083



EX-G076





Safety and Notice

The **HDMI over Single CAT5 Distribution Series**, including

EX-G013A v1.3 1x2 HDMI 1.3 over Single CAT5 Distribution Amplifier,

EX-G015 2x8 HDMI 1.3 over Single CAT5 Distribution Amplifier,

EX-G013B v1.3 1x2 HDMI 1.3 over Single CAT5 Cascading Distribution Amplifier,

EX-G016 2x8 HDMI 1.3 over Single CAT5 Cascading Distribution Amplifier,

EX-G083 HDMI 1.3 over Single CAT5 Receiver, and

EX-G076B HDMI over Single CAT5 Direct Plug-in Receiver

has been tested for conformance to safety regulations and requirements, and has been certified for international use. However, like all electronic equipments, the HDMI over CAT5 Distribution Series should be used with care. Please read and follow the safety instructions to protect yourself from possible injury and to minimize the risk of damage to the unit.

- Follow all instructions and warnings marked on this unit.
- Do not attempt to service this unit yourself, except where explained in this manual.
- Provide proper ventilation and air circulation and do not use near water.
- Keep objects that might damage the device and assure that the placement of this unit is on a stable surface.
- Use only the power adapter and power cords and connection cables designed for this unit.
- Do not use liquid or aerosol cleaners to clean this unit. Always unplug the power to the device before cleaning.

Introduction

The **HDMI 1.3 over Single CAT5 Distribution Series** provides the most flexible solution by which the high definition video and high quality audio can be transmitted to different locations over a long distance. The devices are cascadable, allowing you to extend HDMI/DVI compliant displays almost anywhere.

Diagram 1

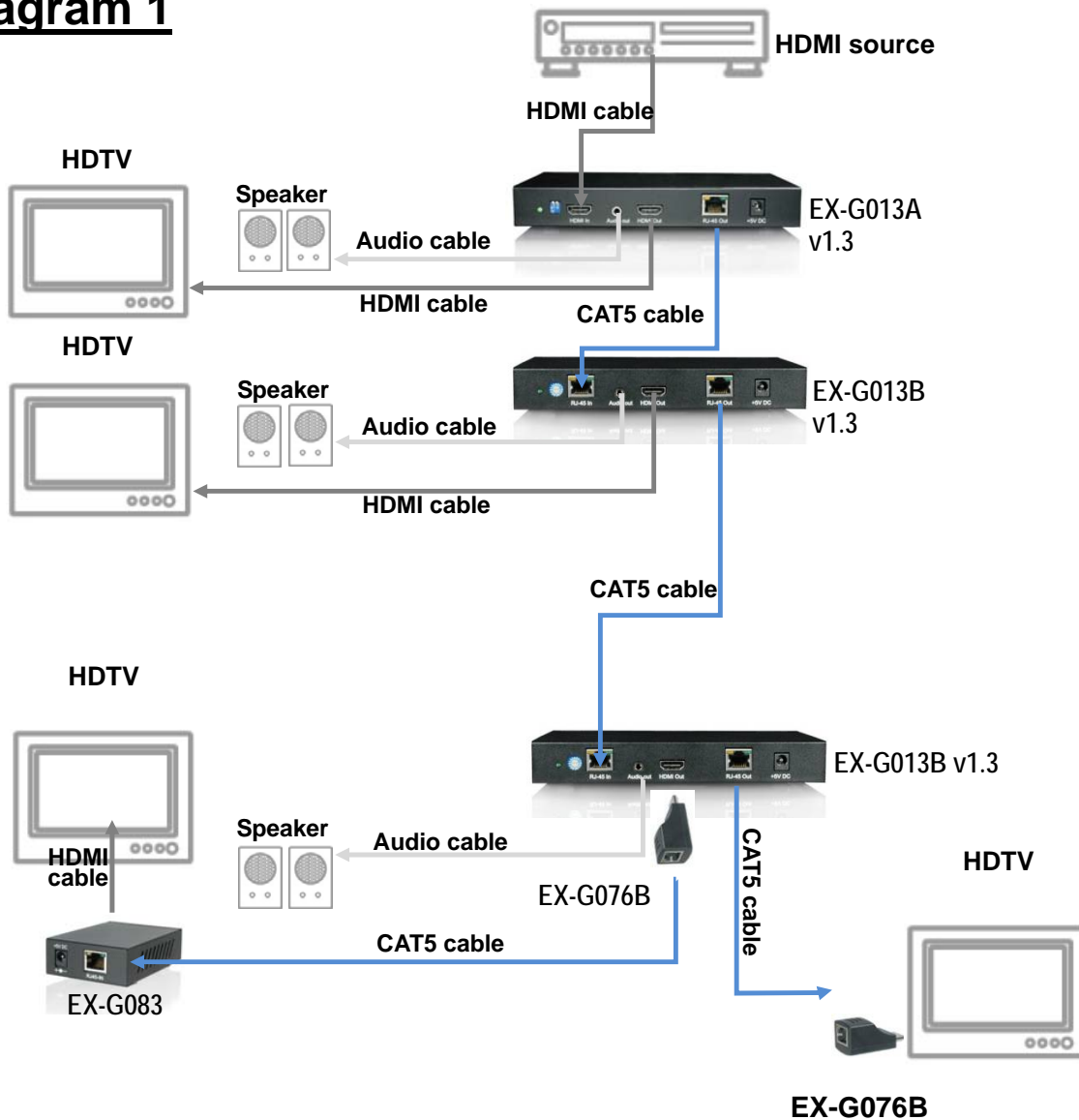

Features

- State-of-the-art Silicon Image (founder of HDMI) chipset embedded for upmost compatibility and reliability
- HDMI 1.3 compliant
- HDCP compliant
- Regenerates the HDMI signal
- Supports audio output
- Supports default HDMI EDID and has the ability to learn the EDID of displays
- Extends up to 15m (50ft) of input HDMI cable
- Extends up to 15m (50ft) of output HDMI cable
- Extends up to 60m (200ft) (720p / 1080i) of output CAT5 cable
- Extends up to 40m (130ft) (1080p) of output CAT5 cable
- Minimize the cable skew by adjustable 8-level equalization control
- Pure unaltered uncompressed 7.1ch digital HDMI over LAN cable transmission
- Allows cascading
- Perfectly integrated with other HDMI over CAT5 series products
- 1U rack mountable [EX-G015 / EX-G016]; wall mountable [EX-G013A v1.3/ EX-G013B v1.3]



The length depends on the characteristics and quality of the cables. Higher resolutions and longer transmission distances require low skew cables (<25ns/100m) for best performance. Unshielded CAT6 with metal RJ-45 connectors is recommended.

Technical Specifications and Package Content

Model Name	EX-G013A v1.3	EX-G013B v1.3
Technical		
Role of usage	1x2 distribution amplifier	
	Transmitter [TX]	Transceiver [TRX]
HDMI compliance	HDMI 1.3	
HDCP compliance	Yes	
Video bandwidth	Single-link 225MHz [6.75Gbps]	
Video support	480i / 480p / 720p / 1080i / 1080p60 36-bit color depth	
Transmission	Full HD (1080p)-40m (130ft) [CAT5e] / 50m (165ft) [CAT6] HD (720p/1080i)-50m (165ft) [CAT5e] / 60m (200ft) [CAT6]	
Audio support	Surround sound (up to 7.1ch) or stereo digital audio	
Equalization	None	8-level digital control
Input TMDS signal	1.2 Volts [peak-to-peak]	
Input DDC signal	5 Volts [peak-to-peak, TTL]	
ESD protection	[1] Human body model — ±15kV [air-gap discharge] & ±8kV [contact discharge] [2] Core chipset — ±8kV	
PCB stack-up	4-layer board [impedance control — differential 100Ω; single 50Ω]	
Input	1x HDMI	1x RJ-45
Output	1x HDMI 1x RJ-45 1x 3.5mm audio socket	1x HDMI 1x RJ-45 1x 3.5mm audio socket
HDMI connector	Type A [19-pin female]	
RJ-45 connector	WE/SS 8P8C with 2 LED indicators	
3.5mm connector	Earphone jack for stereo audio	
DIP switch	EDID/audio mode	None
Mechanical		
Housing	Metal case	
Dimensions [L x W x H]	Model	180 x 108 x 27mm [7" x 4.3" x 1.1"]
	Package	330 x 200 x 95mm [1'1" x 7.9" x 3.7"]
	Carton	495 x 440 x 380mm [1'8" x 1'5" x 1'3"]
Weight	Model	
	Package	
Fixedness	Wall-mounting case	
Power supply	5V 4A DC	
Power consumption	3 Watts [max]	
Operation temperature	0~40°C [32~104°F]	
Storage temperature	-20~60°C [-4~140°F]	
Relative humidity	20~90% RH [no condensation]	
Package Contents	1x EX-G013A v1.3 or EX-G013B v1.3 1x 5V power adapter 1x User Manual	

Model Name		EX-G015	EX-G016
Technical			
Role of usage		2x8 distribution amplifier	
		Transmitter [TX]	Transceiver [TRX]
HDMI compliance		HDMI 1.3c	
HDCP compliance		Yes	
Video bandwidth		Single-link 225MHz [6.75Gbps]	
Video support		480i / 480p / 720p / 1080i / 1080p60 36-bit color depth	
Transmission		Full HD (1080p)-40m (130ft) [CAT5e] / 50m (165ft) [CAT6] HD (720p/1080i)-50m (165ft) [CAT5e] / 60m (200ft) [CAT6]	
Audio support		Surround sound (up to 7.1ch) or stereo digital audio	
Equalization		8-level digital control	
Input TMDS signal		1.2 Volts [peak-to-peak]	
Input DDC signal		5 Volts [peak-to-peak, TTL]	
ESD protection		[1] Human body model — ±15kV [air-gap discharge] & ±8kV [contact discharge] [2] Core chipset — ±8kV	
PCB stack-up		4-layer board [impedance control — differential 100Ω; single 50Ω]	
Input		2x HDMI	1x HDMI 1x RJ-45
Output		8x RJ-45	1x HDMI 7x RJ-45
HDMI connector		Type A [19-pin female]	
RJ-45 connector		WE/SS 8P8C with 2 LED indicators	
DIP switch		6-pin DIP	2-pin DIP
Mechanical			
Housing		Metal case	
Dimensions [L x W x H]	Model	438 x 158 x 44mm [1'5" x 6.2" x 1.7"]	340 x 110 x 44mm [1'1" x 4.3" x 1.7"]
	Package	545 x 230 x 110mm [1'10" x 9.1" x 4.3"]	
	Carton	570 x 580 x 260mm [1'11" x 1'11" x 10.2"]	
Weight	Model		
	Package		
Fixedness		1U rack-mount with ears	
Power supply		5V 4A DC	
Power consumption		13 Watts [max]	
Operation temperature		0~40°C [32~104°F]	
Storage temperature		-20~60°C [-4~140°F]	
Relative humidity		20~90% RH [no condensation]	
Package Contents		1x EX-G015 / EX-G016 2x Rack-mounting ears 1x 5V power adapter 1x User Manual	

Model Name		EX-G083	EX-G076B
Technical			
Role of usage		Receiver [long range RX]	Receiver [short range RX]
HDMI compliance		HDMI 13c	
HDCP compliance		Yes	
Video bandwidth		Single-link 225MHz [6.75Gbps]	
Video support		480i / 480p / 720p / 1080i / 1080p60 36-bit color depth	
Transmission		Full HD (1080p)-40m (130ft) [CAT5e] / 50m (165ft) [CAT6] HD (720p/1080i)-50m (165ft) [CAT5e] / 60m (200ft) [CAT6]	
Audio support		Surround sound (up to 7.1ch) or stereo digital audio	
Equalization		8-level digital control	None
Input TMDS signal		1.2 Volts [peak-to-peak]	
Input DDC signal		5 Volts [peak-to-peak, TTL]	
ESD protection [CV-715]		[1] Human body model — ±15kV [air-gap discharge] & ±8kV [contact discharge] [2] Core chipset — ±8kV	
PCB stack-up		4-layer board [impedance control — differential 100Ω; single 50Ω]	
Input		1x RJ-45	1x RJ-45
Output		1x HDMI	1x HDMI
HDMI connector		Type A [19-pin female]	Type A [19-pin male]
RJ-45 connector		WE/SS 8P8C with 2 LED indicators	
Mechanical			
Housing		Metal case	Plastic mold
Dimensions [L x W x H]	Model	85 x 60 x 25mm [3.3"x2.4"x1"]	45 x 25 x 20mm [1.8"x1"x0.8"]
	Package	270 x 175 x 80mm [10.6"x6.9"x3.2"]	170 x 115 x 40mm [6.7"x4.5"x1.6"]
	Carton	450 x 370 x 300mm [1'6" x 1'3" x 11.8"]	
Weight	Model		22g [0.8oz]
	Package		90g [3.2oz]
Fixedness		Wall-mount case upon request	Direct plug-in
Power supply		5V 2A DC	None
Power consumption		1 Watt [max]	0.5 Watt [max]
Operation temperature		0~40°C [32~104°F]	
Storage temperature		-20~60°C [-4~140°F]	
Relative humidity		20~90% RH [no condensation]	
Package Contents		1x EX-G083 1x 5V power adapter 1x User Manual	1x EX-G076B 1x User Manual

Panel Descriptions

EX-G013A v1.3 1x2 HDMI 1.3 over Single CAT5 Distribution Amplifier



1. Power indicator
2. DIP switch [see table below]
3. **HDMI In:** Connect a HDMI source with a HDMI M-M cable here
4. **Audio out:** Plug in a local speaker here
5. **HDMI Out:** Connect to a HDMI display with a HDMI M-M cable here
6. **RJ-45 Out:** Link to EX-G013A for cascading; or link to EX-G083 or EX-G076B to another HDMI display with a CAT5e/6 LAN cable
7. **+5V DC:** Connect to 5V 4A DC power supply

DIP Switch for EDID/Audio

DIP Switch Position		Video	Audio	Description
Pin#1	Pin#2			
OFF [↑]	OFF [↑]	Up to 1080p	Stereo ¹	Default Mode ² – Up to 1080p & stereo audio output for most HDTVs
OFF [↑]	ON [↓]	Up to 720p / 1080i	Stereo	Safe Mode ³ – Enforce the system output at 720p/1080i video and stereo audio for basic compatibility among HDTVs
ON [↓]	OFF [↑]	Bypass ⁴	Bypass ^{s4}	EDID Learning Mode ⁵ – for learning EDID from the display while playing any received HDMI audio format
ON [↓]	ON [↓]	Bypass	Stereo	EDID Learning & Stereo Mode ⁵ – for learning EDID from the display while enforcing stereo output if any HDTV cannot play surround sound normally



Note

- ¹ If the HDTV shows video but without audio, please try to set audio mode to stereo.
- ² Factory default: Pin#1-OFF[↑], Pin#2- OFF[↑] for 1080p with stereo.
- ³ If you encounter any unsolved audio/video output problem during system installation, please turn to Safe Mode (Pin#1-OFF[↑] & Pin#2-ON[↓]) to enforce the most compatible 720p stereo output for system check.
- ⁴ Bypass means the matrix will maintain playing the original format of HDMI signals in video and perhaps audio. By setting at this mode, the users may encounter compatibility issue among different kinds of HDMI sources and displays. If you cannot get the audio and/or video output normally at the system installation, please change the DIP switch setting to default mode or even safe mode to verify the functionality of the device.
- ⁵ Set Pin#1 at ON[↓] first then connect the HDMI Input to HDTV through a HDMI cable. Wait for 20 seconds. The EDID learning procedure will be finished. If you want to learn the EDID from another HDTV, you must set Pin#1 at OFF first and repeat this procedure.

EX-G013B v1.3 1x2 HDMI 1.3 over Single CAT5 Cascading Distribution Amplifier

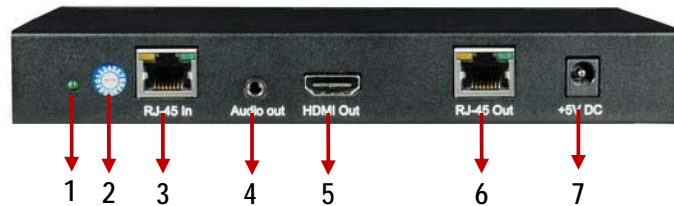

1. Power indicator
2. 16-level rotary control: Adjust the 16-level equalization control corresponding to the transmission distance of receiving HDMI signals. For surround sound audio output, please adjust from 0-to-7 (longest-to-shortest transmission length). For stereo audio output, please adjust from 8-to-F (longest-to-shortest transmission length). It is recommended to adjust from 7-to-0 or from F-to-8 to find the optimal visual experience.
3. **RJ-45 In:** Link to CV-57G-TX, EX-G013A, or EX-G013B with a CAT-5e/6 cable
4. **Audio out:** Plug in a local speaker here
5. **HDMI Out:** Connect to a HDMI display with a HDMI M-M cable here
6. **RJ-45 Out:** Link to another EX-G013B for cascading; or link to EX-G083 or EX-G076B to another HDMI display with a CAT5e/6 cable
7. **+5V DC:** Connect to 5V 4A DC power supply

EX-G083 HDMI 1.3 over Single CAT5 Receiver

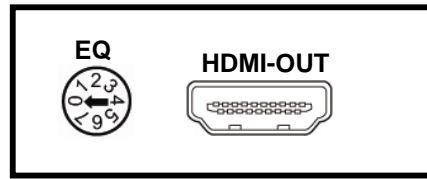

HDMI-OUT: Connect to a HDMI display with a HDMI M-M cable here.

EQ: Adjust the 8-level equalization control knob to the received HDMI signals. 0 – 7 = strongest – weakest. It is recommended to switch from 7 to 0 to find the optimal visual experience.

EX-G015 2x8 HDMI over Single CAT5 Distribution Amplifier



1. **+5V DC:** Power jack for 5V4A DC
2. **HDMI In1:** HDMI Input1 for connecting to a HDMI source here
3. **HDMI In2:** HDMI Input2 for connecting to a HDMI source here
4. **EDID:** DIP Switch (see the definition in the next section)
5. **Out1 – Out8:** RJ-45 Output 1-8 to link to the HDTV through HDMI over CAT5 receiver CV-715 or EX-G076B

DIP Switch

Switch Position	OFF [↑]	ON [↓]
Pin#1	Input HDMI source #1	Input HDMI source #2
Pin#2	Source 1 use default EDID	Source 1 use learned EDID ¹
Pin#3	Source 2 use default EDID	Source 2 use learned EDID ²
Pin#4	7.1 Channel ³	2 Channel
Pin#5	HDMI 1.2 output	HDMI 1.3 output
Pin#6	HDMI mode output	DVI mode output

5. Dip Switch: EDID/Audio setting [see following section]
6. **EQ**: Rotary control for equalizer setting [see following section]
7. **RJ-45 IN 1**: for cascading from another EX-G016 or EX-G013B
8. **HDMI IN 2**: for connecting to video source, EX-G013A, EX-G017A, or another EX-G016
9. **RJ-45 OUT**: for connecting to display through EX-G083 or EX-G076B; or for cascading to another EX-G013B or EX-G016
10. **HDMI OUT1-HDMI OUT7**: for connecting to display through HDMI cable or through Cat-5e cable with EX-G076B attached; or for cascading to another EX-G013A or EX-G016.
11. **+5V DC power**: connect to 5V 4A DC interlocking power adapter
12. Power ON/OFF switch

DIP Switch

Pin#1 Position	OFF [↑]	ON [↓]	Pin#2 Position	OFF [↑]	ON [↓]
EDID Mode	Use Default EDID	Use learned EDID ¹	Audio Mode	7.1 Channel ²	Stereo



Note

¹ Set pin#1-ON[↓] first and then connect the HDMI Input to HDMI display thru HDMI cable. Wait for 20 seconds. The Recording Procedure will be finish. If you want to learn the EDID for another equipped display, you must set pin#1-OFF[↑] and repeat the procedure.

² If the equipped display shows video but without audio, please try to set audio to 2 channel.

Rotary Control



In order to adapt the CAT5 cable, EX-G016 offers 8 level equalization control on the received HDMI signal. The strongest equalization is applied while the knob stops at number 0, while the weakest equalization happens at number 7. It is recommended to switch from 7 to 0 to find the optimal visual experience.

HDMI Output Format Selection

When input signal exists, the output format LED turns on. If the input HDMI source is HDMI 1.3 format, you can set the output format to HDMI 1.2 mode and Red LED will be on. If the input HDMI source is HDMI 1.2, the output format is always set to HDMI 1.2.

EX-G013B v1.3

Relays HDMI signals to next cascading device with one local display

1. Switch off all devices, including monitors.
2. Connect a local HDMI display to the HDMI Out of the EX-G013B and then connect a speaker to the 3.5mm audio socket.
3. Connect to EX-G013B via RJ-45 in by a CAT5 cable.
4. Connect to next EX-G013B (for cascading), to EX-G083 (to HDTV at long range), or EX-G076B (to HDTV at mid range) via RJ-45 out by a CAT5 cable.
5. Plug in 5V 4A DC power supply.
6. Power on the HDTV.

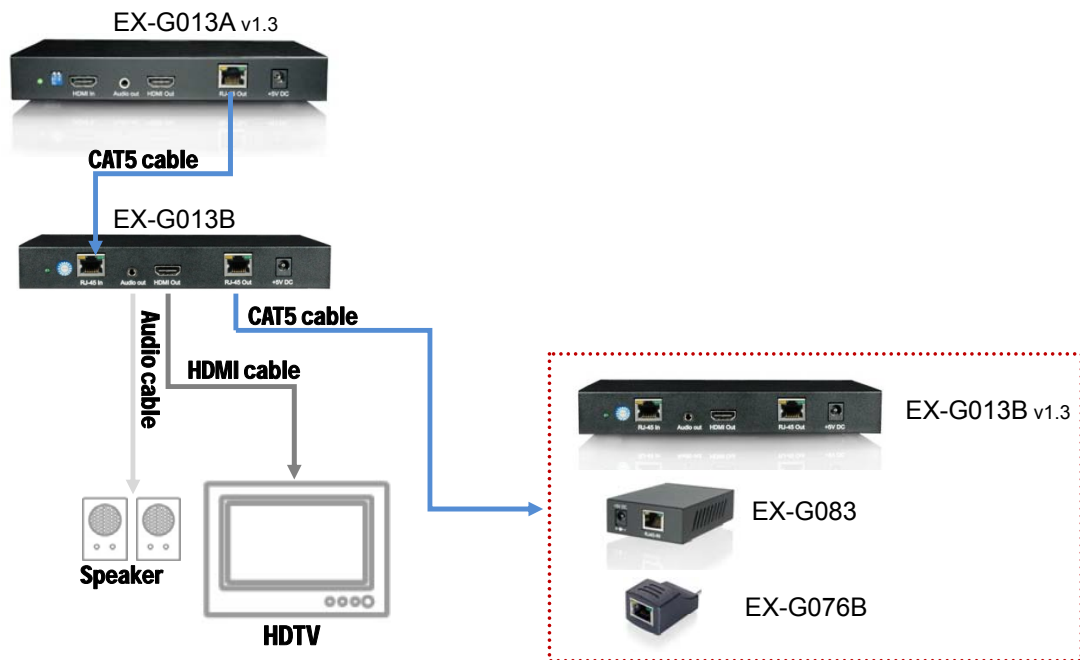

ACE PLUS CORP.

EX-G013B v1.3

Relays HDMI signals to next cascading device with one local display

1. Switch off all devices, including monitors.
2. Connect a local HDMI display to the HDMI Out of the EX-G013B and then connect a speaker to the 3.5mm audio socket.
3. Connect to EX-G013B via RJ-45 in by a CAT5 cable.
4. Connect to next EX-G013B (for cascading), to EX-G083 (to HDTV at long range), or EX-G076B (to HDTV at mid range) via RJ-45 out by a CAT5 cable.
5. Plug in 5V 4A DC power supply.
6. Power on the HDTV.

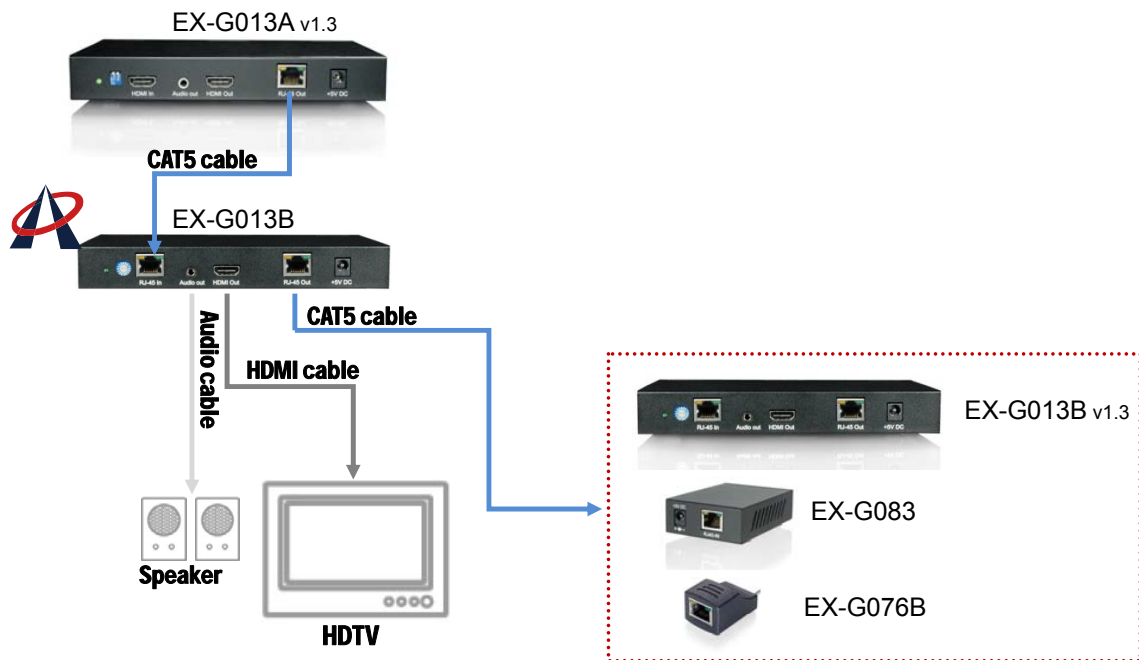

EX-G015

Broadcasts HDMI signals to 8 remote displays from either of two HDMI sources

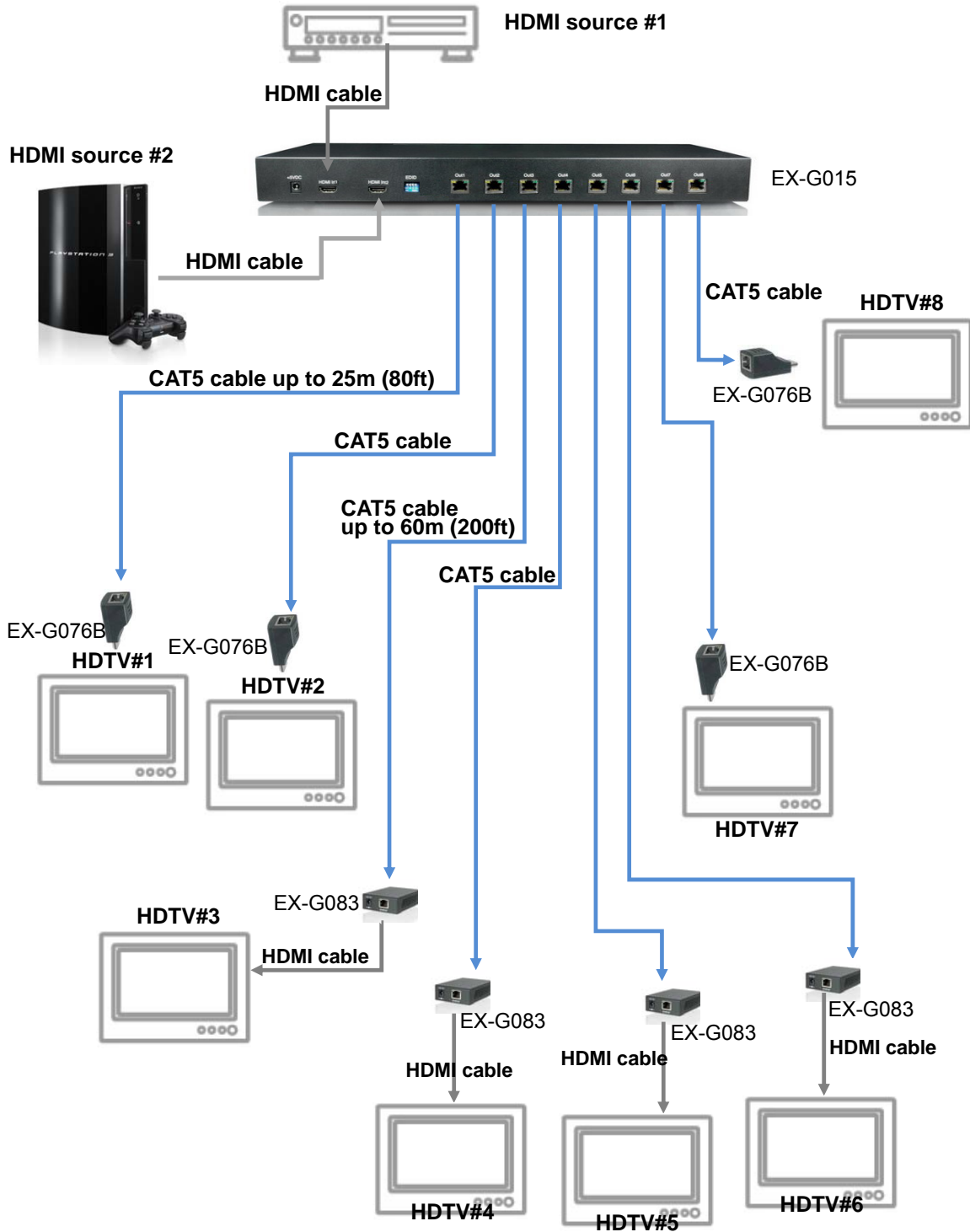

EX-G016

Broadcasts HDMI signals to 7 HDMI displays and cascade to another EX-G016

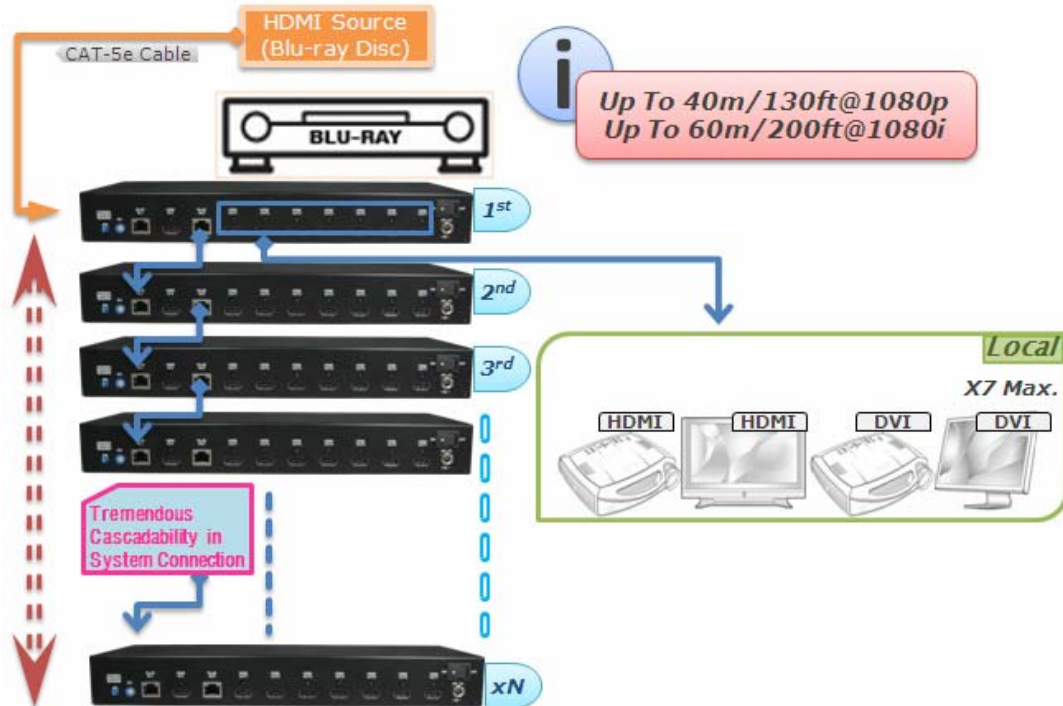

HDMI Pin Definition

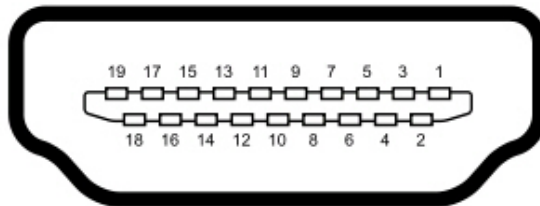

Type A (Receptacle) HDMI

Pin 1	TMDS Data2+	Pin 8	TMDS Data0 Shield	Pin 15	SCL
Pin 2	TMDS Data2 Shield	Pin 9	TMDS Data0-	Pin 16	SDA
Pin 3	TMDS Data2-	Pin 10	TMDS Clock+	Pin 17	DDC/CEC Ground
Pin 4	TMDS Data1+	Pin 11	TMDS Clock Shield	Pin 18	+5 V Power
Pin 5	TMDS Data1 Shield	Pin 12	TMDS Clock-	Pin 19	Hot Plug Detect
Pin 6	TMDS Data1-	Pin 13	CEC		
Pin 7	TMDS Data0+	Pin 14	Reserved (N.C. on device)		

Notice

1. If the DVI or HDMI device requires the EDID information, please use EDID Reader/Writer to retrieve and provide DVI/HDMI EDID information.
2. All HDMI over CAT5 transmission distances are measured using Belden 1583A CAT5e 125MHz LAN cable and ASTRODESIGN Video Signal Generator VG-859C.
3. The transmission length is largely affected by the type of LAN cables, the type of HDMI sources, and the type of HDMI display. The testing result shows solid LAN cables (usually in bulk cable 300m/1000ft form) can transmit a lot longer signals than stranded LAN cables (usually in patch cord form). Shielded STP cables are better suit than unshielded UTP cables. A solid UTP CAT5e cable shows longer transmission length than stranded STP CAT6 cable. For long extension users, solid LAN cables are your only choice.
4. EIA/TIA-568-B termination (T568B) for LAN cables is recommended for better performance.
5. To reduce the interference among the unshielded twisted pairs of wires in LAN cable, you can use shielded LAN cables to improve EMI problems, which is worsen in long transmission.
6. Because the quality of the LAN cables has the major effects in how long transmission distance will be made and how good is the received display, the actual transmission length is subject to your LAN cables. For resolution greater than 1080i or 1280x1024, a CAT6 cable is recommended.
7. If your HDMI display has multiple HDMI inputs, it is found that the first HDMI input [HDMI input #1] generally can produce better transmission performance among all HDMI inputs.



Performance Guide for HDMI over LAN Cable Transmission

Performance rating		Type of LAN cable		
Wiring	Shielding	CAT5	CAT5e	CAT6
Solid	Unshielded (UTP)	★★★	★★★★★	★★★★★
	Shielded (STP)	★★★	★★★	★★★★★
Stranded	Unshielded (UTP)	★	★★	★★
	Shielded (STP)	★	★	★★
Termination		Please use EIA/TIA-568-B termination (T568B) at any time		

Limited Warranty

The SELLER warrants the **HDMI 1.3 over Single CAT5 Distribution Series** to be free from defects in the material and workmanship for 1 year from the date of purchase from the SELLER or an authorized dealer. Should this product fail to be in good working order within 1 year warranty period, The SELLER, at its option, repair or replace the unit, provided that the unit has not been subjected to accident, disaster, abuse or any unauthorized modifications including static discharge and power surge. This warranty is offered by the SELLER for its BUYER with direct transaction only. This warranty is void if the warranty seal on the metal housing is broken.

Unit that fails under conditions other than those covered will be repaired at the current price of parts and labor in effect at the time of repair. Such repairs are warranted for 90 days from the day of reshipment to the BUYER. If the unit is delivered by mail, customers agree to insure the unit or assume the risk of loss or damage in transit. Under no circumstances will a unit be accepted without a return authorization number.

The warranty is in lieu of all other warranties expressed or implied, including without limitations, any other implied warranty or fitness or merchantability for any particular purpose, all of which are expressly disclaimed.

Proof of sale may be required in order to claim warranty. Customers outside Taiwan are responsible for shipping charges to and from the SELLER. Cables and power adapters are limited to a 30 day warranty and must be free from any markings, scratches, and neatly coiled.

The content of this manual has been carefully checked and is believed to be accurate. However, The SELLER assumes no responsibility for any inaccuracies that may be contained in this manual. The SELLER will NOT be liable for direct, indirect, incidental, special, or consequential damages resulting from any defect or omission in this manual, even if advised of the possibility of such damages. Also, the technical information contained herein regarding the **HDMI 1.3 over Single CAT5 Distribution Series** features and specifications is subject to change without further notice.

